

STERN

STERN ENGINEERING LTD.



EXTREME CS

Extreme CS B Extreme CS E
Extreme CS DP B Extreme CS DP E

WALL MOUNTED ELECTRONIC FAUCET
FOR COLD OR PREMIXED WATER

INSTALLATION AND MAINTENANCE GUIDE

INDEX

- 1 TECHNICAL DATA
- 2 PACK CONTENTS
- 2 OPERATION
- 3 PRE-INSTALLATION INFO
- 4 FAUCET INSTALLATION
- 5-8 RANGE ADJUSTMENT
- 9 BATTERY REPLACEMENT INSTRUCTIONS
- 10 MAINTENANCE
- 11 SPARE PARTS LIST
- 12 LIMITED WARRANTY
- 13 TROUBLE SHOOTING

The information in this document reflects products at the date of printing. Stern Engineering Ltd reserves the right, subject to all applicable laws, at any time, at its sole discretion, and without notice, to discontinue or change the features, designs, materials and other specifications of its products, and to either permanently or temporarily withdraw any of the foregoing from the market. All information in this document is provided "as is" without warranty of any kind, either expressed or implied, including but not limited to any implied warranties of merchantability, fitness for a particular purpose, or non-infringement. Stern Engineering Ltd assumes no responsibility for errors or omissions in the information presented in this document. In no event shall Stern Engineering Ltd be liable for any special, incidental, indirect or consequential damages of any kind, or any damages whatsoever arising out of or in connection with the use or performance of this information. The tradenames, trademarks, logos and service marks presented in this document, including their design, are the property of Stern Engineering Ltd or other third parties and you are not permitted to use them without the prior written consent of Stern Engineering Ltd or such third party as may own them.

TECHNICAL DATA

EXTERME CS

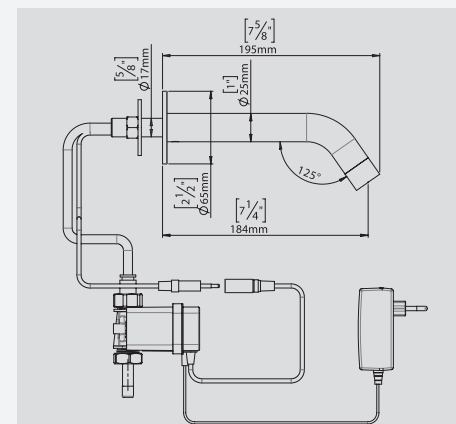

Extreme CS E 237800

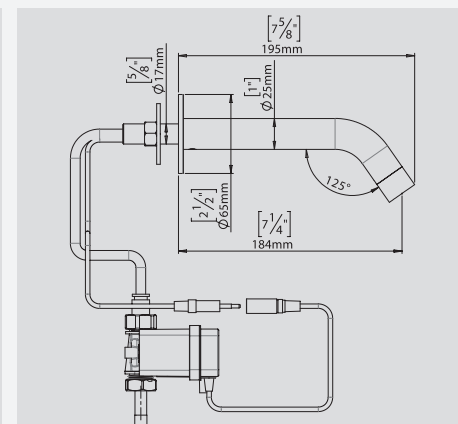

Extreme CS B 237801

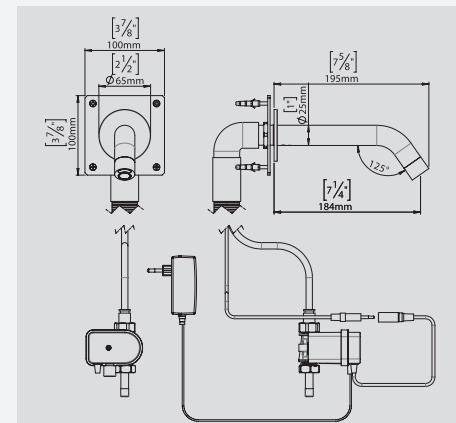

Extreme CS DPE 237803

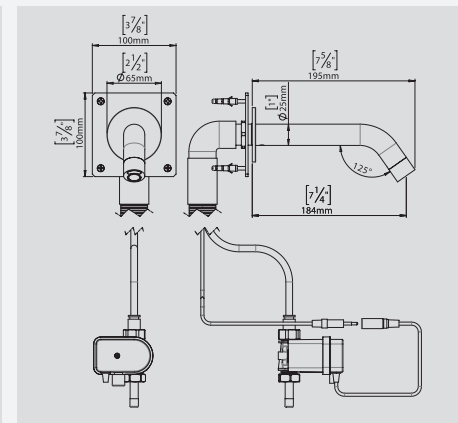

Extreme CS DPB 237802

Power supply for battery versions:	9V battery
Power supply for electricity versions:	9V transformer
Recommended water pressure	0.5-8.0 bar (7-116 PSI). With water pressure of more than 8 bars, use a pressure reducing valve.
Preset sensor range:	95 mm. Adjustable.
Flow time:	90 seconds. Adjustable with remote control.
Hot water temperature:	Max. 70° C

PACK CONTENTS

EXTERME CS

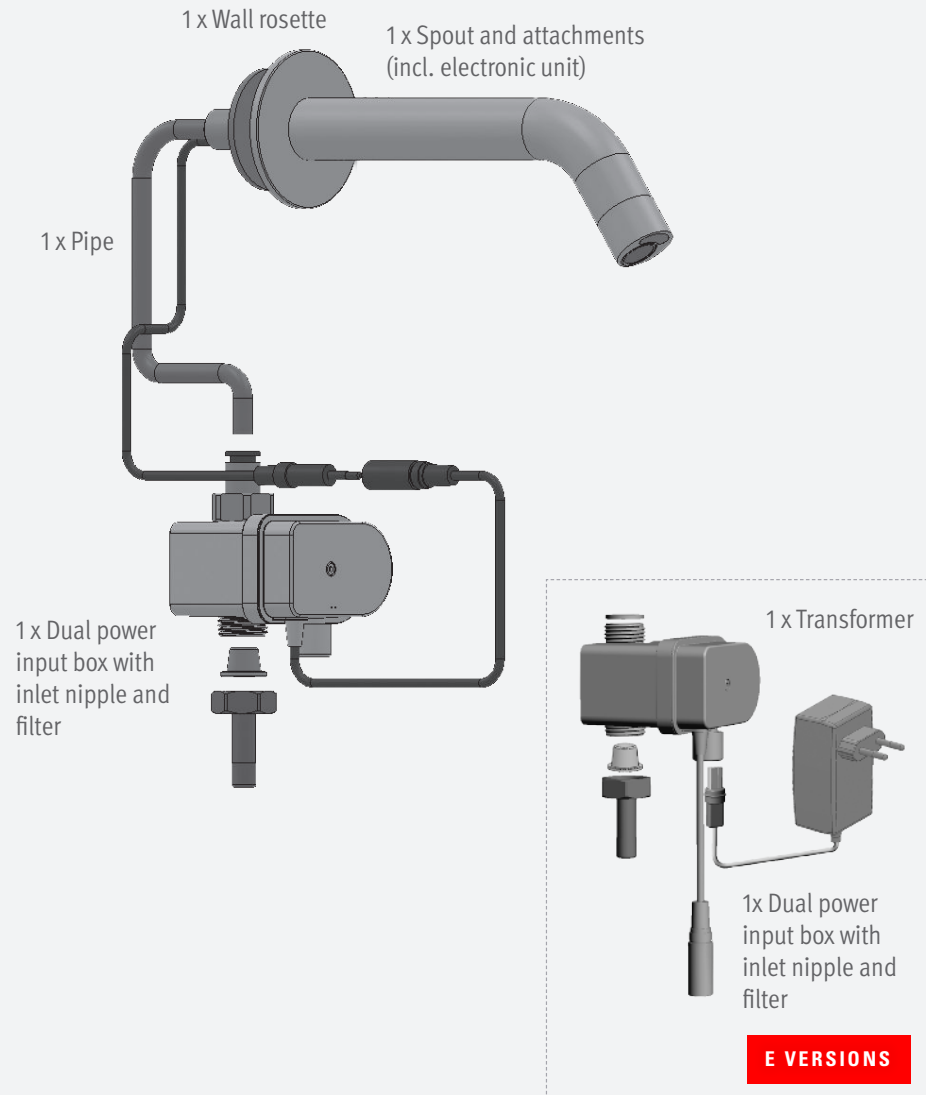

PACK CONTENTS

EXTERME CS DP

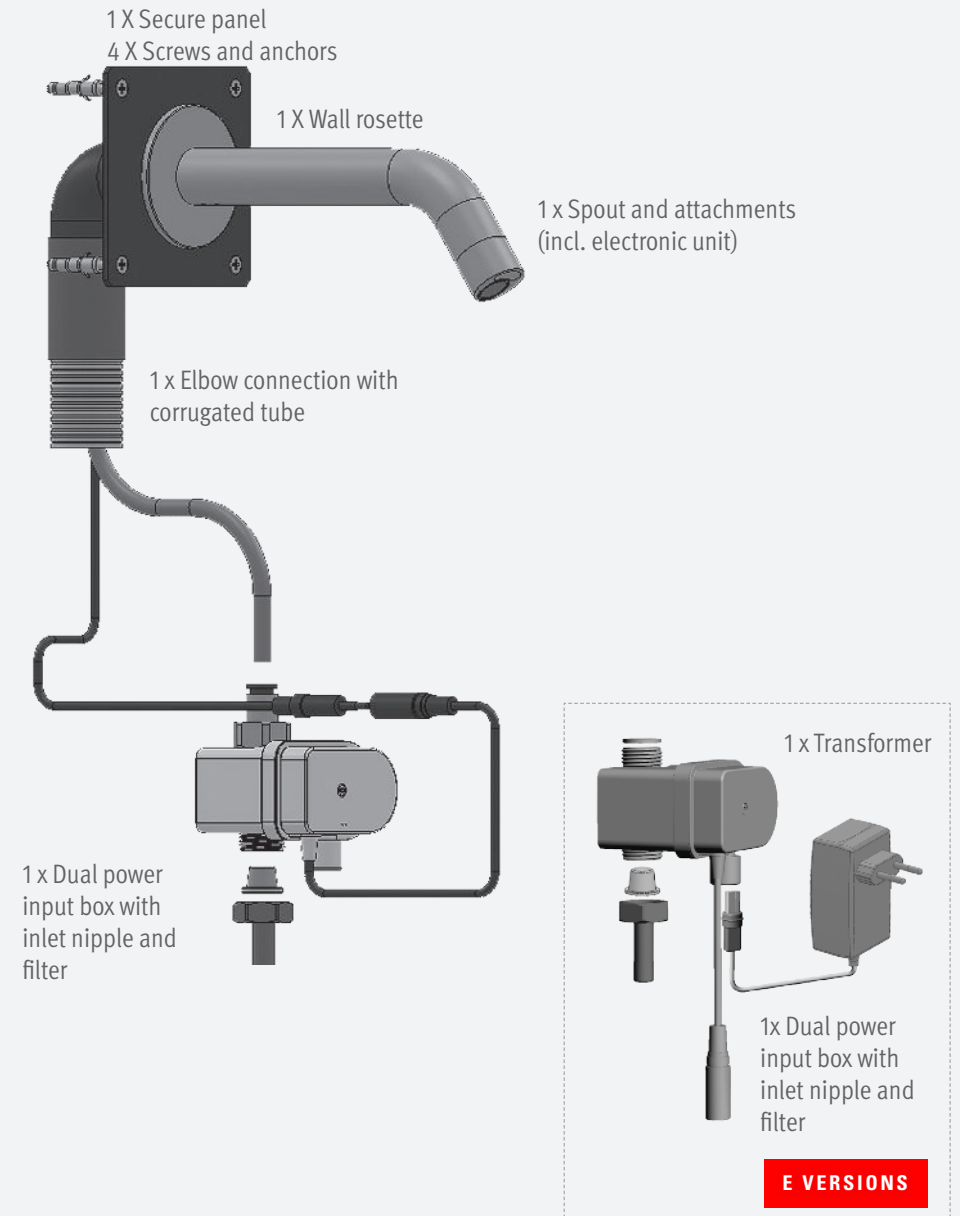

PRE-INSTALLATION INFO

Check contents

Separate all parts from packaging and check each part with the pack contents section. Make sure all parts are accounted for before discarding any packaging material. If any parts are missing, do not attempt to install the electronic faucet until you obtain the missing parts.

Warnings

Do not install the system facing a mirror or any other electronic system operated by an infra-red sensor.

To prevent reflection problems, it is recommended keep a minimum distance of 300 mm (11.81 inch) between the faucet and other objects.

Preparation for installation

Flush water supply lines thoroughly before installing the faucet. Do not allow dirt, Teflon tape or metal particles to enter the faucet.

All plumbing is to be installed in accordance with applicable codes and regulations.

Care and cleaning of chrome and special finishes

DO NOT use steel wool or cleansing agents containing alcohol, acid, abrasives, or the like. Use of any prohibited cleaning or maintenance products or substances could damage the surface of the faucet. For surface cleaning use ONLY soap and water, then wipe dry with clean cloth or towel. When cleaning bathroom tile, the faucet should be protected from any splattering of harsh cleansers.

If system chemical disinfection is practiced, chlorine can be used (calculated chlorine concentration of 50mg/l maximum in water per one hour dwell time) at service interval frequency.

INSTALLATION

EXTREME CS E/B

Note: Prior to installation flush water lines.

STEP 1 – INSTALLING THE FAUCET

1

Shut off the water supply.

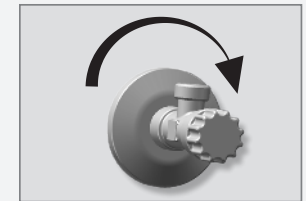

2

Drill a hole (18 to 20 mm) in the location you wish to install the faucet.

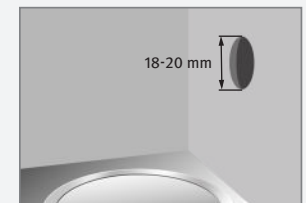

3

Insert the faucet base through the wall and fix it firmly on the opposite side with the hexagonal nut and the disk.

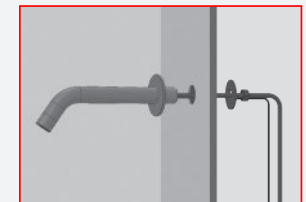

INSTALLATION

EXTREME CS DPE/DP B

STEP 1 – INSTALLING THE FAUCET

- 1 Shut off the water supply.

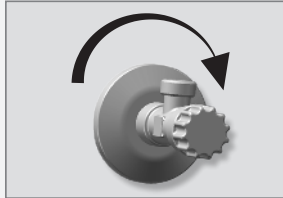

- 2 Cut an adequate sized hole in the wall for the dimensions of the faucet base (see Technical Data).

- 3 Install the faucet base firmly to the roughing wall.

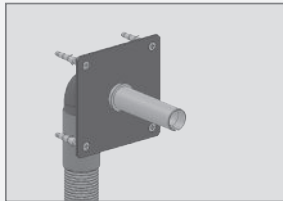

- 4 Attach the temporary protective cover over the faucet base.

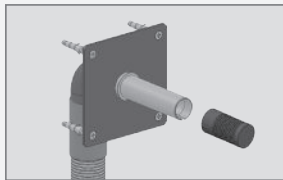

NOTE: Make sure that the corrugated tube outlet remains outside of the wall during tiling. Access is needed after the completion for the wall.

- 5 Once the electrical, plumbing and tile work is complete cut off the temporary faucet base cover. Then slide the rosette on the base of the faucet.

- 6 Pass the four pin connector and the black flexible tube (connected to the faucet head) through the base of the faucet until they can be accessed from the opposite side of the corrugated green tube.

- 7 Place the faucet on the base and secure it with the set screw on the bottom.

INSTALLATION

STEP 2 – CONNECTING THE WATER SUPPLY

- Remove the plastic tip that is inserted in the end of the black flexible tube.
- Connect the dual power box to the water supply lines.
- Connect the black flexible tube to the quick connector on the top of the dual power box.
- Place battery into the Dual Power input box.

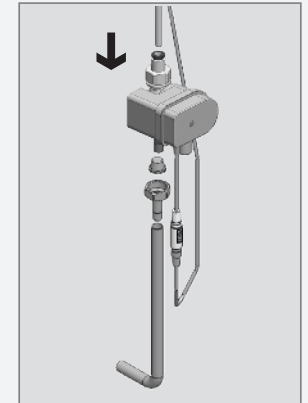

STEP 3 – CONNECTING THE POWER SOURCE

- 1 Turn on the central water supply. Check for leaks. Remove the protective sticker from the sensor.

- 2 Connect the power source.

- 3 Once the power source is connected, wait 15 seconds to allow the system to set the ideal sensor range. A LED will flash continuously to indicate this adjustment period. The solenoid valve will open for 1 second to indicate that the ideal sensor range was set.



- 2 If the automatically adjusted sensor range is not satisfactory to your purposes, please refer to the section entitled “Settings adjustment”.

SETTINGS ADJUSTMENT



Adjusting the settings with the remote control

If necessary, the sensor settings can be adjusted as following:

Shut off the water supply. In order to adjust the sensor with the remote control, hold the remote control straight in front of the sensor in a distance of about 6-8" (15-20cm). Choose the function you want to adjust by pressing once on one of the function buttons. After pressing once on a specific function button, a quick flashing of the LED at the front of the sensor will occur. At this stage, you can change the setting by pressing the (+) or the (-) buttons, every push will increase or decrease one level. After finishing the adjustment, turn the water supply back on.

SETTINGS ADJUSTMENT



DETECTION RANGE: This faucet was supplied with a self adjusting sensor. The ideal detection range for the specific location will be set automatically.

Only if necessary, use the remote control to adjust the sensor range as follows:

Press the RANGE button. Wait until a quick flashing of the LED in the sensor eye is perceived. Then, press + to increase the range and – to reduce it. Every push will increase or decrease one level.

Note: Once you have changed the detection range with the remote control, the distance will be remembered by the sensor, even if the power source is disconnected. To get back to the self adjustment mode, use the ADJ button only.



ENTRANCE TO THE SELF ADJUSTMENT MODE: Check that no objects are in front of the sensor. Press the ADJ button. Once a quick flashing of the LED of the sensor eye is perceived, remove your hand holding the remote control and move away from the sensor area. The ideal sensor range for the specific location will be set automatically. Once the self adjustment has taken place, the solenoid valve will be opened and closed for 1 second as an indication that the ideal sensor range was set and the product is ready for use.



SECURITY TIME: The Security time, prevents continuous running of water due to reflections or vandalism. By default, if the sensor is covered for more than 90 seconds the water flow will shut automatically. To resume regular operation any obstruction must be removed.

Press the SEC button. Wait until a quick flashing of the LED in the sensor eye is perceived. Then, press + to increase the security time and – to reduce it.

SETTINGS ADJUSTMENT



DELAY IN TIME: It is recommended to change the delay in time for flush valves for urinals or toilets only.

If required, the delay in time can also be modified in faucets as follows:

Press the IN button. Wait until a quick flashing of the LED in the sensor eye is perceived. Then, press + to increase the delay in time and – to reduce it.



DELAY OUT TIME: This button allows modifying the water flow time after the user removes his hands from the faucet. A delay out time close to 0 will save more water. An increased delay out time will make the user experience more comfortable.

If required, the delay out time can be modified as follows:

Press the OUT button. Wait until a quick flashing of the LED in the sensor eye is perceived. Then, press + to increase the delay out time and – to reduce it.



24 HOUR HYGIENE FLUSH: This model includes a 24 hours hygiene flush which is disabled. To activate the hygiene flush, press the clock button. Wait until a quick flashing of the LED in the sensor eye is perceived. Then press + to activate the hygiene flush. To disable it again, press – to deactivate it.



COMFORT FLUSH: If your model includes a Comfort flush setting, it can be activated by pressing the flush button.

When the button is pressed, one blink of the LED in the sensor eye is perceived. The pre-programmed flush cycle will take place then.

The Comfort flush cannot be interrupted or deactivated by pressing any button until it is over.



TEMPORARY OFF FUNCTION: This function is ideal to perform any kind of activity in front of the sensor without operating the system (for example, cleaning).

The faucet will remain shut for 1 minute when this button is pressed once. To cancel this function and to return to normal operation press the On/Off button again or wait 1 minute.



RESET BUTTON: This function restores all the factory settings except for the sensor range. If required, press the Reset button and without releasing it, press the + button once.

NOTE: To enter the self adjusting mode, use the ADJ button. To change the sensor range, use the RANGE button.

MAINTENANCE

Filter cleaning instructions

This tap is provided with a stainless steel filter preventing foreign particles to enter the lines. If the water flow has decreased, this may be because the filter is clogged. The filter can be cleaned as follows:

1. Shut-off the water shut off valve.
2. Disconnect the water supply pipe from the adaptor and disassemble the filter from it.
3. Wash the filter under running water.
4. Reassemble the parts.
5. Restore the incoming water supply.
6. Make sure that there is no water leakage.

Care and cleaning of chrome and special finishes

DO NOT use steel wool or cleansing agents containing alcohol, acid, abrasives, or the like. Use of any prohibited cleaning or maintenance products or substances could damage the surface of the faucet. For surface cleaning of faucet use ONLY soap and water, then wipe dry with clean cloth or towel. When cleaning bathroom tile, the faucets should be protected from any splattering of harsh cleansers.

If system chemical disinfection is practiced, chlorine can be used (calculated chlorine concentration of 50mg/l maximum in water per one hour dwell time) at service interval frequency.

BATTERY REPLACEMENT

Battery models only

When the battery weakens, the LED indicator light will blink at a constant rate when the user's hands are within the sensor range. The battery must be replaced within two weeks. Always use batteries from a reputable source. Poor quality batteries may affect the performance of the product.

To replace the battery:

Carefully open the dual power input box using the Allen key provided. Remove the old battery and replace it with a new 9V battery (Lithium battery is recommended). Close the box lid and tighten it with the screw.

Important: Spent batteries should not be disposed of with normal household waste. Contact your local authority for information on waste disposal and recycling.



SPARE PARTS

10-Pack Sensor Kit	07220412
10-Pack Solenoid valve kit Extreme CS	07232005
Dual Power Input Box	06530042
12-Pack 9V Transformer (EU)	06540003
10-Pack Diaphragm	04500048
Remote Control (Optional)	07100005
Soap & Water Remote Control (Optional)	07100014

LIMITED WARRANTY

Y. Stern Engineering Ltd. warrants that its electronic products will be free of defects in material and workmanship during normal use for two years from the date the product is purchased.

If a defect is found in normal use, Y. Stern Engineering Ltd. will, at its discretion, repair, provide a replacement part or product, or make appropriate adjustments. Damage caused by accident, misuse, or abuse is not covered by this warranty. Improper care and cleaning will void the warranty. Proof of purchase (original sales receipt) must be provided to Stern Engineering Ltd. with all warranty claims.

Stern Engineering Ltd is not responsible for labor charges, installation, or other incidental or consequential costs other than those noted above. In no event shall the liability of Stern Engineering Ltd. exceed the purchase price of the product.

If you believe that you have a warranty claim, contact your Stern Distributor, Dealer or Plumbing Contractor. Please be sure to provide all pertinent information regarding your claim, including a complete description of the problem, the product, model number, the date the product was purchased, from whom the product was purchased and the installation date. Also include your original invoice.

Y. STERN ENGINEERING AND/OR SELLER DISCLAIM ANY LIABILITY FOR SPECIAL, INCIDENTAL OR CONSEQUENTIAL DAMAGES. This warranty excludes product damage due to installation error, incorrect maintenance, wear and tear, battery, product abuse, or product misuse, whether performed by a contractor, service company, or the consumer. This warranty does not cover product damage caused by the following:

- Incorrect installation.
- inversions of supply pipes.
- Pressures or temperatures exceeding recommended limits.
- Improper manipulation, tampering, bad or lapsed maintenance.
- Foreign bodies, dirt or scale introduced by the water supply or soap tank.
- Use of the soap outside of viscosity specifications.
- Alteration of the original soap/foam dispenser components (including pipes).

TROUBLESHOOTING

PROBLEM	INDICATOR	CAUSE	SOLUTION
No water is coming out of the faucet:	1. LED light in the sensor does not flash once when user's hands are within the sensor's range.	1. Range is too short.	Increase the range
		2. Range is too long.	Decrease the range
		3. Unit is in "Security Mode"**	
	4. Sensor is picking up reflections from the washbasin or another object.	Eliminate the cause of reflection.	
2. LED light in the sensor flashes once when user's hands are within the sensor's range.	1. Debris or scale in solenoid.	Unscrew solenoid, pull out the plunger and the spring from the solenoid and clean them. Use scale remover material if needed. When replacing the plunger, please make sure that the spring is in vertical position.	
	2. The central orifice in the diaphragm is plugged or the diaphragm is torn	Clean the orifice or replace the diaphragm.	
	3. The water supply pressure is higher than 8 bar.	Reduce the supply water pressure.	
	4. The water supply pressure is under 8 bars and yet the pressure in the faucet's body is higher. This situation could be caused by a sudden increase in the water supply pressure that the backcheck prevents from dropping, even after water supply pressure drops under 8 bars.	Shut off the water supply and unscrew one of the flexible pipes in order to reduce the pressure that blocks the product.	
Water flow from spout does not stop:	1. Sensor flashes once when user's hands are within the sensor's range.	1. Debris or scale in diaphragm	Clean the orifice or replace the diaphragm.
		2. Connectors between the electronic unit and the Dual power input box are disconnected or not connected properly	Connect the connectors properly. <i>Refer to page 11.</i>
2. LED light in the sensor does not flash once when user's hands are within the sensor's range.	1. Sensor is dirty or covered.	Clean or eliminate the cause of interference.	
	2. Sensor is picking up reflections from the washbasin or another object.	Decrease the range or eliminate the cause of reflection.	
Water flow diminished		Filter or aerator is clogged	Remove, clean, re-install the filter or aerator

* "Security Mode": If the sensor is covered for more than 90 sec. the faucet will automatically shut off water flow. To return to normal operation remove any blockage to re-establish operation.

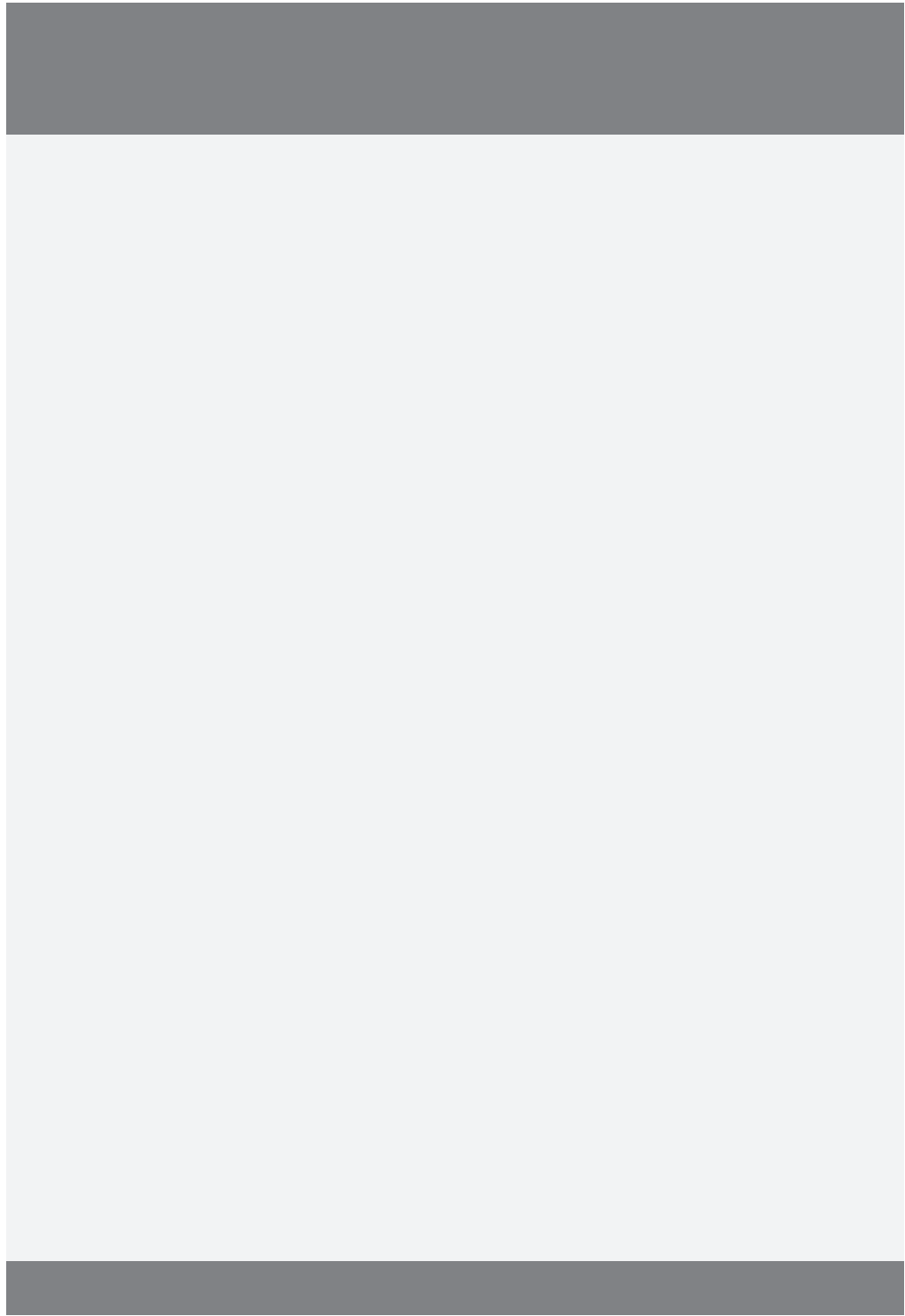
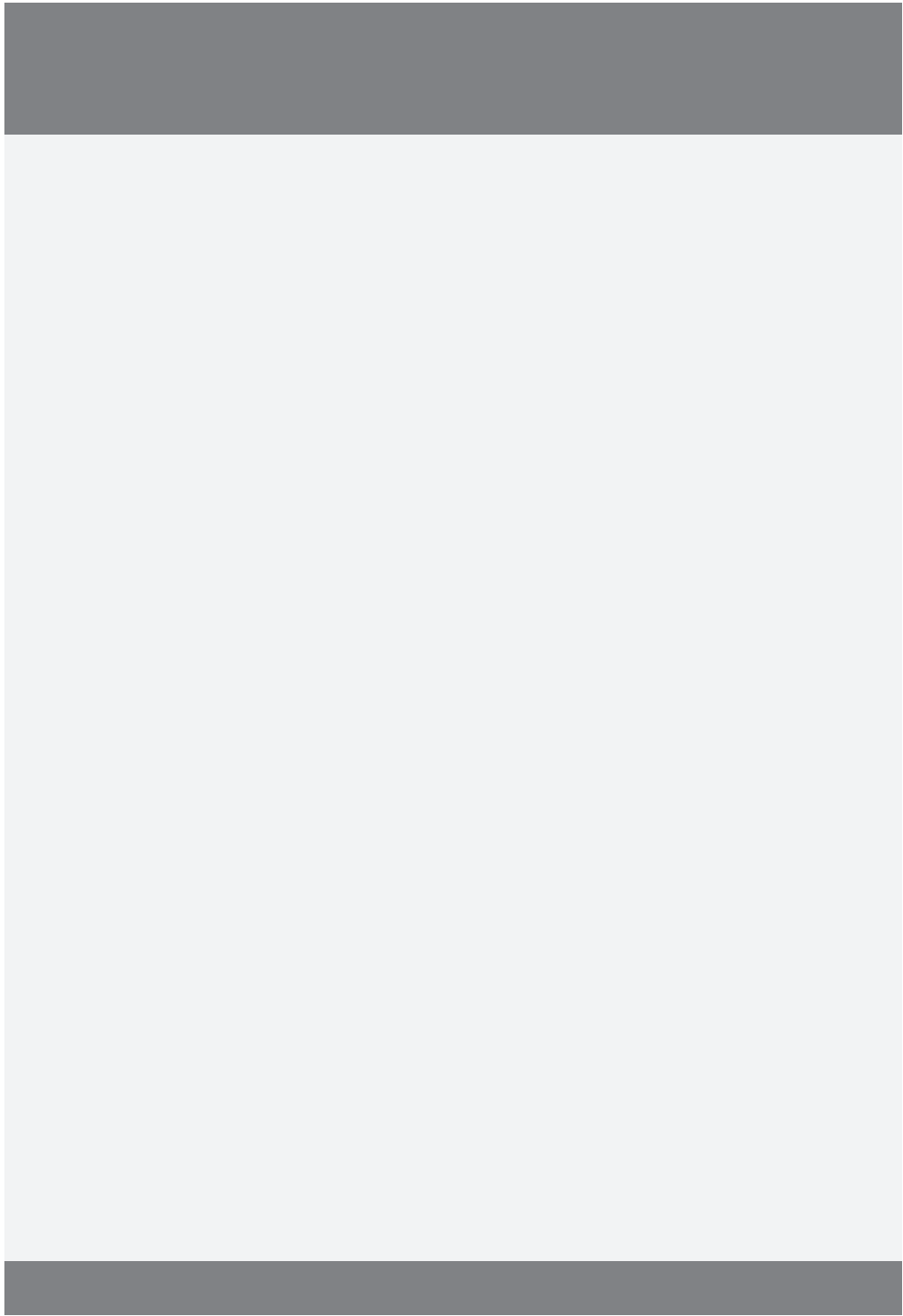

stern

STERN ENGINEERING LTD.

777 Passaic Avenue, Clifton NJ, 07012, USA

Tel: +1-973 773 8011 | Fax: +1-973-779-8768

Toll Free: 1-800-4364410

info@sternfaucets.com | tech@sternfaucets.com

